

# Colt™ Series C400, C500

RP/IS-A-C400/C500

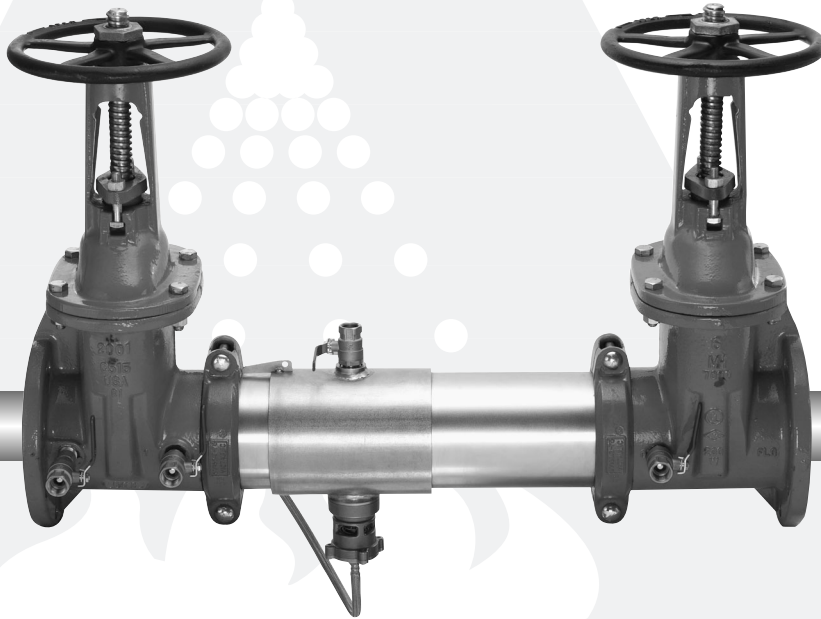

## Reduced Pressure Zone Assemblies

## Reduced Pressure Detector Assemblies

Sizes: 2½" – 10" (65 – 250mm)

- Installation
- Service
- Repair Kits
- Maintenance

**Installation Note:** Due to shipping, storage, and general handling, the Victaulic Coupling for the shutoff valves may have loosened and should be retightened during installation.

### CALIFORNIA PROPOSITION 65 WARNING

**WARNING:** This product contains chemicals known to the State of California to cause cancer and birth defects or other reproductive harm. (California law requires this warning to be given to customers in the State of California.)  
For more information: [www.watts.com/prop65](http://www.watts.com/prop65)

For other repair kits and service parts, send for Ames Repair Parts Price List, PL-A-RP-BPD.

For technical assistance, contact your local Ames representative.

**IMPORTANT:** Inquire with governing authorities for local installation requirements.

**NOTE:** For Australia and New Zealand, line strainers should be installed between the upstream shutoff valve and the inlet of the backflow preventer.

It's important that this device be tested periodically in compliance with local codes, but at least once per year or more as service conditions warrant. If installed on a fire sprinkler system, all mechanical checks, such as alarm checks and backflow preventers, should be flow tested and inspected internally in accordance with NFPA 13 and NFPA 25.

**Limited Warranty:** Ames Fire & Waterworks (the "Company") warrants each product to be free from defects in material and workmanship under normal usage for a period of one year from the date of original shipment. In the event of such defects within the warranty period, the Company will, at its option, replace or recondition the product without charge.

**THE WARRANTY SET FORTH HEREIN IS GIVEN EXPRESSLY AND IS THE ONLY WARRANTY GIVEN BY THE COMPANY WITH RESPECT TO THE PRODUCT. THE COMPANY MAKES NO OTHER WARRANTIES, EXPRESS OR IMPLIED. THE COMPANY HEREBY SPECIFICALLY DISCLAIMS ALL OTHER WARRANTIES, EXPRESS OR IMPLIED, INCLUDING BUT NOT LIMITED TO THE IMPLIED WARRANTIES OF MERCHANTABILITY AND FITNESS FOR A PARTICULAR PURPOSE.**

The remedy described in the first paragraph of this warranty shall constitute the sole and exclusive remedy for breach of warranty, and the Company shall not be responsible for any incidental, special or consequential damages, including without limitation, lost profits or the cost of repairing or replacing other property which is damaged if this product does not work properly, other costs resulting from labor charges, delays, vandalism, negligence, fouling caused by foreign material, damage from adverse water conditions, chemical, or any other circumstances over which the Company has no control. This warranty shall be invalidated by any abuse, misuse, misapplication, improper installation or improper maintenance or alteration of the product.

Some States do not allow limitations on how long an implied warranty lasts, and some States do not allow the exclusion or limitation of incidental or consequential damages. Therefore the above limitations may not apply to you. This Limited Warranty gives you specific legal rights, and you may have other rights that vary from State to State. You should consult applicable state laws to determine your rights. **SO FAR AS IS CONSISTENT WITH APPLICABLE STATE LAW, ANY IMPLIED WARRANTIES THAT MAY NOT BE DISCLAIMED, INCLUDING THE IMPLIED WARRANTIES OF MERCHANTABILITY AND FITNESS FOR A PARTICULAR PURPOSE, ARE LIMITED IN DURATION TO ONE YEAR FROM THE DATE OF ORIGINAL SHIPMENT.**

# Basic Installation Instructions

## Guidelines

1. Most field problems occur because dirt and debris present in the system at the time of installation becomes trapped in the #1 check. **The system should be flushed before the valve is installed.** If the system is not flushed until after the valve is installed, remove both check modules from the valve and open the inlet shutoff to allow water to flow for a sufficient time to flush debris from the water line. If debris in the water system continues to cause fouling, a strainer can be installed upstream of the backflow assembly.
2. The Series C400 and C500 may be installed in either horizontal, "N" pattern, or "Z" pattern position as long as the backflow assembly is installed in accordance with the direction of the flow arrow on the assembly and the local water authority approves the installation.
3. The assembly should be installed with adequate clearance around the valve to allow for inspection, testing and servicing. 12" (300mm) should be the minimum clearance between the lower portion of the assembly and the floor or grade. The valve should be protected from freezing.
4. Installing a backflow preventer in a pit or vault is not recommended.
5. Normal discharge and nuisance spitting are accommodated by the use of an Ames air gap fitting and a fabricated indirect waste line. Floor drains of the same size must be provided in case of excessive discharge.
6. The C400 and C500 backflow preventer should be tested by a certified tester at the time of installation.

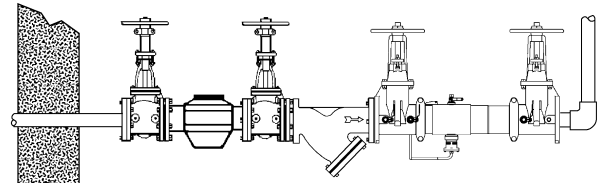

Horizontal Installation

**Note: Assembly body should not be painted.**

## Relief Valve Discharge Rates

2½" – 10" (65-250mm) C400 and C500

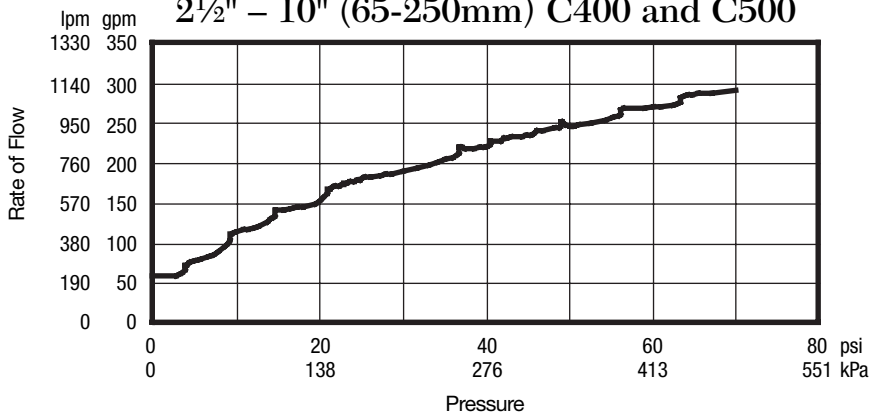

# Maintenance Instructions 2½" – 6" (65 – 150mm)

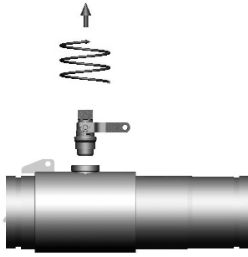

Figure A

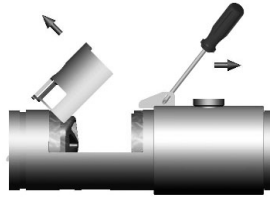

Figure B

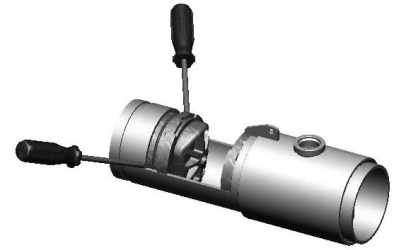

Figure C

## #1 Check Diagrams



Figure D



Figure E

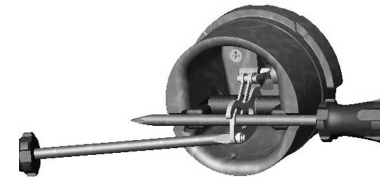

Figure F

## #2 Check Diagrams

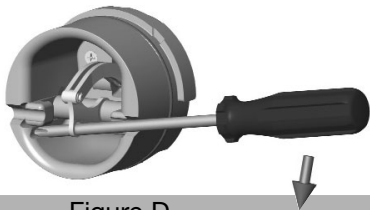

Figure D

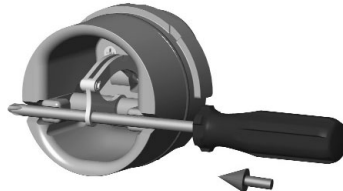

Figure E



Figure F

## Instructions

**Prior to servicing any Ames valve, it is mandatory to shut down the water system by closing both the inlet and outlet shutoff valves. After shutoff valves are closed, open test cock #2, #3 and #4 to relieve pressure within the backflow assembly.**

1. After #3 test cock has been opened to relieve pressure, remove #3 test cock from housing. (Figure A)
2. Insert a #3 screwdriver through the hole on the top of the cover sleeve and using both hands rotate the cover sleeve approximately ¼-turn clockwise and ¼-turn counter-clockwise to break the sleeve O-ring seals. Using the screwdriver, slowly slide the cover sleeve to the downstream side of the housing. (Figure B)
3. Remove the stainless steel check retainer from the housing. (Figure B)
4. Remove the #1 check module (Figure C) by inserting two flat blade screwdrivers into the slots on either side of the check module and gently pry the check module toward the open zone.
5. Remove #2 check module with the same instructions as in #4 above. For servicing 6" (150mm) checks see 8" – 10" (200 – 250mm) instructions on p.4.
6. To clean or inspect either check module, insert a #3 screwdriver through the downstream side of the check module as shown in Figures D and E. When the screwdriver is in place, remove the E-clip (Figure F) and pin connecting the structural members and the check clapper will open with no tension.
7. Thoroughly clean the seating area. The sealing disc may be removed, if necessary, by removing the screws connecting the keeper plate to the clapper. The sealing disc may be reversed and reinstalled if the elastomer is cut or damaged.
8. Wash check module and O-ring and inspect for any damage. If damaged, reinstall new parts.
9. After thorough cleaning, lubricate O-ring w/FDA approved lubricant, replace pin and E-clip in structural members, remove screw driver, reinstall check modules and assemble housing in reverse order of these instructions.

# Maintenance Instructions 8" – 10" (200 – 250mm)

---

## Material/Tool Requirements:

- #4 Phillips screwdriver or  $\frac{3}{8}$ " diameter rod, length sufficient to span diameter of check, see Figures A and B.
- $\frac{1}{2}$  – 13 x 5 fully threaded hex bolt (Service bolt).
- $\frac{3}{4}$ " open end or socket wrench.

## Instructions:

**Prior to servicing any Ames valve, it is mandatory to shut down the water system by closing both the inlet and outlet shutoff valves. After shutoff valves are closed, open test cock #2, #3 and #4 to relieve pressure within the backflow assembly.**

1. After #3 test cock has been opened to relieve pressure, remove #3 test cock from housing. When repairing an 8" or 10" (200 – 250mm) device, remove both Victaulic couplers from body. Slide the downstream Victaulic coupler gasket to the downstream side of the housing. The upstream Victaulic coupler gasket stays in place.
2. Remove check(s) to be maintained.
3. Locate the service hole and thread in the service bolt by hand until it contacts the linkage. (Figure A)
4. Continue to thread in service bolt with the wrench until the service hole in the linkage is aligned with the service notches on the spring arbors. (Figure A)
5. Insert the Phillips screwdriver through the arbors and service hole of the linkage making sure that the tip of the screwdriver extends past the ends of the arbors by a minimum of  $\frac{1}{4}$ " (6mm). (Figure B)
6. Back out the service bolt until load is transferred to the screwdriver. Continue to back out the service bolt until sufficient clearance is achieved to remove the complete spring mechanism.
7. To disconnect linkage, remove retaining clip and pin (store in a safe location for reinstallation).
8. To remove spring mechanism, grasp the screwdriver at the center, pull complete assembly straight out and store in a safe place.
9. Reinstall in reverse.

**WARNING – While the spring mechanism is removed for check servicing; never pull the screwdriver out or off the support notches on the arbors. Doing so may cause bodily injuries.**

Figure A

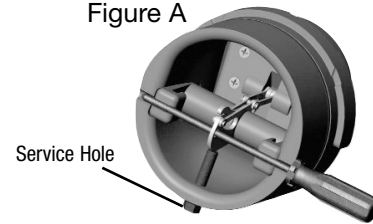
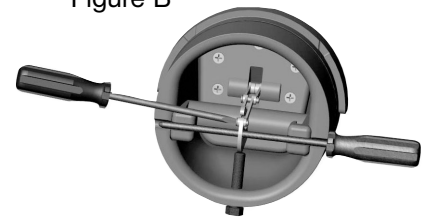

Figure B



# Servicing Relief Valve

Prior to servicing the relief valve, it is mandatory to shut down water system by closing both the inlet and outlet shutoff valves and relieving pressure within the assembly by opening the #2, #3 and #4 test cocks.

**DO NOT REMOVE SPIDER BUSHING FOR SERVICING.**

1. Disconnect the hose from the bottom cover plate to the relief valve.
2. An O-ring seals the relief valve body to the main housing. It is not necessary to tighten the connection beyond firm hand tightening. The relief valve should be able to be removed by hand untightening. Unscrew the relief valve from the housing.
3. Remove the cover plate of the relief valve by removing the four connecting screws.
4. Remove the rubber diaphragm from the relief valve. Be aware of how the diaphragm is configured so that it can be reinstalled in the same manner. The hard rubber tab in the diaphragm fits into a similar socket in the head of the piston. (Figure 1)

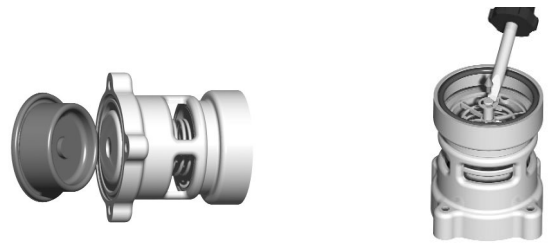

Figure 1

Figure 2

5. Hold the relief valve in both hands with the threaded end up and both thumbs on the head of the piston. Push up on the piston until the piston shaft with the attached E-clip is exposed. Remove the E-clip (Figure 2)
6. Remove the piston and spring from the relief valve housing and thoroughly clean all parts including the diaphragm. Inspect all rubber parts for damage and if damaged, replace them with new parts.
7. Reassemble the relief valve in the reverse order that it was disassembled.

## Testing — Reduced Pressure Zone Assemblies

### Test No.1

**Purpose:** To test check valve No. 2 for tightness against reverse flow.

**Requirements:** Valve must be tight against reverse flow under all pressure differentials. Slowly open the 'high' valve A and the 'vent' valve C, and keep the 'low' valve B closed. Open test cock #4. Indicated pressure differential will decrease slightly. If pressure differential continues to decrease (until the vent opens) check valve #2 is reported as 'leaking'.

### Test No. 2

**Purpose:** To test shutoff #2 for tightness.

**Requirements:** After passing Test No. 1, continue to Test No. 2 by closing test cock #2. The indicated pressure differential will decrease slightly. If pressure differential continues to decrease (approaching 'zero'), shutoff #2 is reported to be 'leaking'.

### Test No. 3

**Purpose:** To test check Valve No. 1 for tightness.

**Requirements:** Valve must be tight against reverse flow under all pressure differentials. Close 'high' valve A and open test cock #2. Close test cock #4. Disconnect vent hose at test cock #4. Open valves B and C, bleeding to atmosphere. Then closing valve B restores the system to a normal static condition. Observe the pressure differential gauge. If there is a decrease in the indicated value, check valve No. 1 is reported as 'leaking'.

### Test No. 4

**Purpose:** To test operation of pressure differential relief valve.

**Requirements:** The pressure differential relief valve must operate to maintain the 'zone' between the two check valves at least 2psi less than the supply pressure. Close 'vent' valve C. Open 'high' valve A. Open the 'low' valve B very slowly until the differential gauge needle starts to drop. Hold the valve at this position and observe the gauge reading at the moment the first

discharge is noted from the relief valve. Record this as the opening differential pressure of the relief valve.

**Note:** It is important that the differential gauge needle drops slowly. Close test cocks #2 and #3. Use 'vent' hose to relieve pressure from test kit by opening valves A, B and C Remove all test equipment and open shutoff #2.

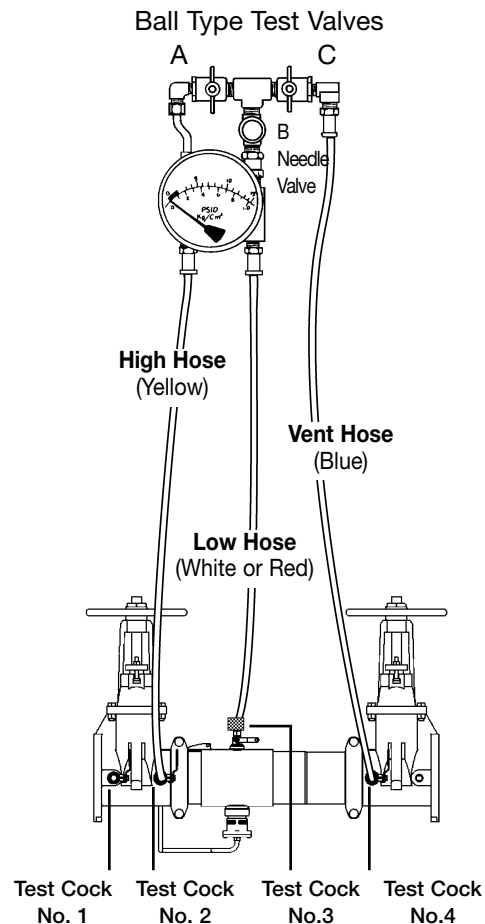

# Replacement Parts Listing

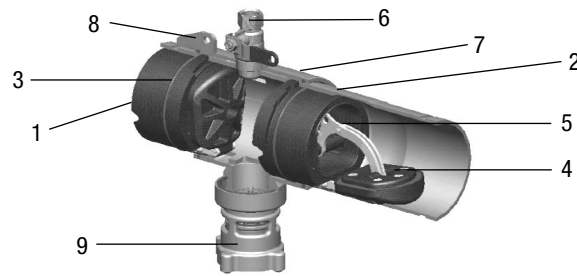

ITEM NO.	DESCRIPTION	ORDERING CODE 2½" (65MM)	ORDERING CODE 3" (80MM)	ORDERING CODE 4" (100MM)
1.	First Check Module (EPDM)	7018112	7018112	7018112
1.	First Check Module (Red Silicone)	7018760	7018760	7018760
2.	Second Check Module (a) (EPDM)	7018120	7018120	7018120
2.	Second Check Module (a) (Red Silicone)	7018764	7018764	7018764
3.	O-ring, Check Module	7017861	7017861	7017861
4.	Disc, Elastomer Shut Off (EPDM)	7018329	7018329	7018329
4.	Disc, Elastomer Shut Off (Red Silicone)	7017855	7017855	7017855
5.	Grooved Clevis Pin Kit (Contains: "E" Clip & Clevis Pin - 5 per pack)	7018126	7018126	7018126
6.	Closure Sleeve Test-Cock with O-ring	7018152	7018152	7018152
7.	Closure Sleeve	7017881	7017881	7017881
8.	Sleeve O-ring or Gasket (2 req'd)	7017896	7017896	7017896
9.	Relief Valve Assembly (Hose included)	7018107	7018107	7018107
NS	Check Repair Kit (Contains: O-ring, Shutoff EPDM Disc & "E" clip)	7018391	7018391	7018391
NS	Check Repair Kit (Contains: O-ring, Shutoff Red Silicone Disc & "E" clip)	7018123	7018123	7018123
NS	"E" Clip	7017870	7017870	7017870
NS	Test Cock, .50 FPT x FPT with Nipple	7018394	7018394	7018394
NS	Test Cock, .75 FPT x FPT with Nipple	N/A	N/A	N/A
NS	Groove Coupler (Shutoff)	7017994	7017995	7018147
NS	Groove Coupler Gasket	7018882	7018883	7018884
NS	Sleeve Coupler Assembly	N/A	N/A	N/A
NS	Air Gap Drain	7018367	7018367	7018367
NS	Splash Guard (only)	7018894	7018894	7018894
NS	O-ring, #3 Test Cock	7017897	7017897	7017897
NS	Stainless Steel Check Retainer	7018408	7018408	7018408

ITEM NO.	DESCRIPTION	ORDERING CODE 6" (150MM)	ORDERING CODE 8" (200MM)	ORDERING CODE 10" (250MM)
1.	First Check Module (EPDM)	7018115	—	—
1.	First Check Module (Red Silicone)	7018761	7018118	7018401
2.	Second Check Module (a) (EPDM)	7018121	—	—
2.	Second Check Module (a) (Red Silicone)	7018765	7018119	7018402
3.	O-ring, Check Module	7017910	7013301	7018352
4.	Disc, Elastomer Shut Off (EPDM)	7017903	—	—
4.	Disc, Elastomer Shut Off (Red Silicone)	7017903	7017928	7018348
5.	Grooved Clevis Pin Kit (Contains: "E" Clip & Clevis Pin - 5 per pack)	7018127	7018127	7018412
6.	Closure Sleeve Test-Cock with O-ring	7018153	7018153	7018153
7.	Closure Sleeve	7017883	7017885	7017887
8.	Sleeve O-ring or Gasket (2 req'd)	7017921	7017944	7018339
9.	Relief Valve Assembly (Hose included)	7018107	7018107	7018107
NS	Check Repair Kit (Contains: O-ring, Shutoff EPDM Disc & "E" clip)	7018392	—	—
NS	Check Repair Kit (Contains: O-ring, Shutoff Red Silicone Disc & "E" clip)	7018124	7018125	7018414
NS	"E" Clip	7017821	7017821	7017974
NS	Test Cock, .50 FPT x FPT with Nipple	N/A	N/A	N/A
NS	Test Cock, .75 FPT x FPT with Nipple	7018395	7018395	7018395
NS	Groove Coupler (Shutoff)	7018148	7018149	N/A
NS	Groove Coupler Gasket	7013248	7013308	N/A
NS	Sleeve Coupler Assembly	N/A	7018122	7018413
NS	Air Gap Drain	7018367	7018367	7018367
NS	Splash Guard (only)	7018894	7018894	7018894
NS	O-ring, #3 Test Cock	7017897	7017897	7017897
NS	Stainless Steel Check Retainer	7018409	7018410	7018411

# Relief Valve Replacement Parts Listing

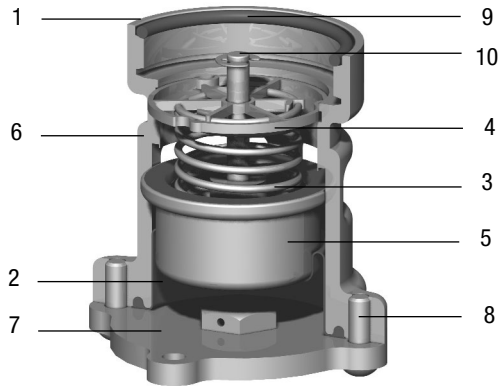

ITEM NO.	DESCRIPTION	ORDERING CODE
1.	Relief Valve Assembly	7018107
2.	Diaphragm, RV	7017809
3.	Spring, RV	7013368
4.	Spider Bushing, RV	7017811
5.	Piston Assembly, RV*	7018227
6.	Body, RV	7018889
7.	Hose & Cover Plate Assembly	7018228
8.	Screw, Cover RV	7017822
9.	O-ring, Inlet coupler	7017826
10.	'E' Clip (5 per pack)	7017870
NS	Sensing Elbow	7018888

ITEM NO.	DESCRIPTION	USE FOR	ORDERING CODE
NS	Hose (1/2"x20")	2 1/2" & 3 M400, M500	7018890
NS	Hose (1/2"x24")	2 1/2" & 3 M400 N & Z	7018891
NS	Hose (1/2"x30")	6 M400, 2.5, 3, 4 M500, 2 1/2", 3, 4 M400 N & Z, 2 1/2", 3, 4 M500 N & Z, 2 1/2" & 3 M500 N & Z BFG	7018892
NS	Hose (1/2"x36")	8 & 10 M400, 6, 8, 10 M400 N & Z, 4 & 6 M400BFG N & Z, 6, 8, 10 M500, 6, 8, 10 M500 N & Z, 4 & 6 M500BFG N & Z	7018893

\*includes shutoff disc

## Troubleshooting Guide

Difficulty	Possible Cause	Correction
Relief valve discharges water while system is not flowing	#1 check is fouled	Remove and clean #1 check
	Relief valve does not properly close	Service relief valve
	Municipal water pressure is fluctuating	Install check valve upstream of backflow assembly
Relief valve does not shut off properly	Fouled relief valve seat	Service relief valve
	Incorrectly installed diaphragm	Remove diaphragm and correctly install
	Damaged rubber surface on piston	Replace with new piston
	Damaged or plugged pressure hose	Repair or replace hose.

For additional information, visit our web site at: [www.amesfirewater.com](http://www.amesfirewater.com)



[www.amesfirewater.com](http://www.amesfirewater.com)



A Division of Watts Water Technologies, Inc.

**USA: Backflow-** 1427 N. Market Blvd • Suite #9 • Sacramento, CA 95834 • T: 916-928-0123 • F: 916-928-9333

**Control Valves-** 18550 Hansen Road • Houston, TX 77075 • T: 713-943-0688 • F: 713-944-9445

**Canada:** 5435 North Service Rd. • Burlington, ONT. L7L 5H7 • T: 905-332-4090 • F: 905-332-7068

RP/IS-A-C400/C500 0904

EDP#7018381

©Ames Fire & Waterworks 2009